

GT51-SDXXX9X-5W-XXX Data Sheet

Features (產品特徵)

- ◆ Maintenance free, easy installation
(免維護, 安裝方便)
- ◆ No need ballast, power in-built, plug and play
(不需要安定器, 內置電源, 即插即用)
- ◆ NO UV or IR light radiation
(沒有紫外線和紅外線輻射光)
- ◆ Long Lifetime >40000 hours
(壽命>40000小時)
- ◆ Power consumption up to **5W** for
lengths **298 mm**
(消耗功率:5W, 燈管長度:298MM)
- ◆ No fluorescent flickering
(沒有螢光燈的閃爍問題)
- ◆ No mercury and ROHS compliant
(沒有汞可通過無鉛環保認證)



Typical Applications (典型應用)

- ◆ Indoor Lighting (室內照明)
- ◆ Architectural Lighting (建築照明)
- ◆ Office Lighting (辦公照明)
- ◆ Decorative lighting (裝飾照明)
- ◆ T5 Luminaire Replacement (替代傳統 T5 光源)

Product Specifications (產品規格)

| Parameter(參數) | Description(描述) |
|-----------------------------|------------------------------------|
| Optical lens (透光罩) | Plastic Cover optical lens(PC 擴光罩) |
| Housing (主體) | Heat dissipation Plastic (散熱塑膠) |
| Operation Temperature(操作溫度) | -20°C ~ +40°C |
| Storage Temperature(儲存溫度) | -30°C ~ +60°C |

GT51-SDXXX9X-5W-XXX Data Sheet

Part Number Explanation (產品編碼)

| Model(產品類型) | Length(長度規格) | LED Type(LED 類型) |
|------------------------------|------------------------------|------------------------------|
| GT51 -SDXXX9X-5W-XXX | GT5 1 -SDXXX9X-5W-XXX | GT51- S DXXX9X-5W-XXX |
| GT5: T5 Whole Tube (T5 一體燈管) | 1: 298mm (1ft) | S: SMD LED |

| CRI(顯色指數) | CCT(色溫) | COVER(PC 罩類型) |
|-------------------------------|-------------------------------|------------------------------|
| GT51-SD D XXX9X-5W-XXX | GT51-SD XX XX9X-5W-XXX | GT51-SDXX X 9X-5W-XXX |
| D: ≥ 80 Ra | 30: 2500~3500K | B: Haze(擴光霧面罩) |
| | 40: 3500~4500K | |
| | 60: 5500~6500K | |

| Input Voltage(使用電壓) | Power Factor(功率因數) | Power Specification(電壓類型) |
|-------------------------------|------------------------------|---------------------------------|
| GT51-SDXXX X 9X-5W-XXX | GT51-SDXXX 9 X-5W-XXX | GT51-SDXXX9 X -5W-XXX |
| A: AC 175~265V | 9: ≥ 0.9 | F: No certification(無安規認證) |
| C: AC 90~305V | | C: Safety certification (有安規認證) |

| Wattage(消耗功率) | Certification (安規類型) |
|------------------------------|--------------------------------|
| GT51-SDXXX9X- 5W -XXX | GT51-SDXXX9X-5W- XXX |
| 5W: 5W | -: BSMI certification (台灣認證) |
| | CE: CE certification (CE 認證) |
| | PSE: PSE certification(PSE 認證) |

Specifications of Haze Cover Series (擴光霧面罩參數)

| Model No. (產品型號) | | GT51-SDXXBX9X-5W-XXX | |
|------------------------------|-------------------------------|----------------------|------|
| Parameter (參數) | | Min. | Typ. |
| Power Consumption (W) (消耗功率) | | | 5 |
| Net Weight (g) (產品重量) | | | 80 |
| D30(2500~3500K) | Luminous Flux (lm) (光通量) | | 495 |
| D40(3500~4500K) | Illuminance @ 1m (lux) (1米照度) | 90 | |
| D60(5500~6500K) | Luminous Flux (lm) (光通量) | | 550 |
| | Illuminance @ 1m (lux) (1米照度) | 100 | |

Power Consumption, Weight, Luminous flux measurement allowance is $\pm 15\%$.

All specifications involving life and performance are based upon a 25°C ambient temperature. (以上資料公差為 $\pm 15\%$ 、測試的資料是在25°C的環境溫度下進行)

GT51-SDXXX9X-5W-XXX Data Sheet

Mechanical Dimensions (產品尺寸圖)

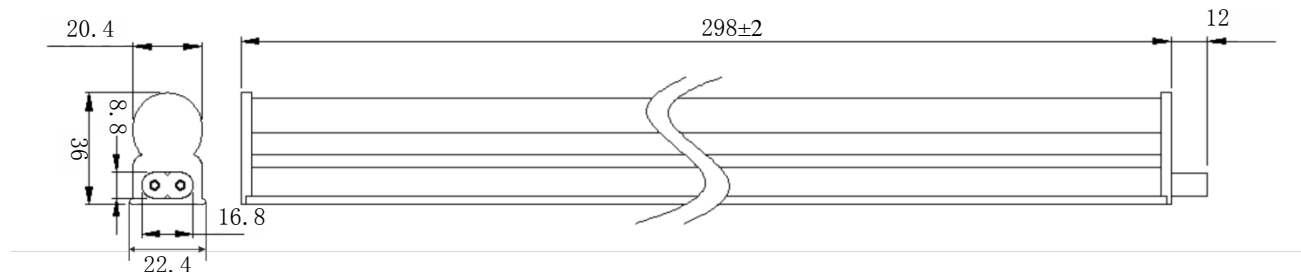

Notes(注釋): 1. Dimensions are in millimeters (上圖尺寸資料單位為: MM)

2. Tolerances unless dimensions $\pm 0.5\text{mm}$ (沒注公差的數據公差為: $\pm 0.5\text{mm}$)

Wiring Diagram (接線圖)

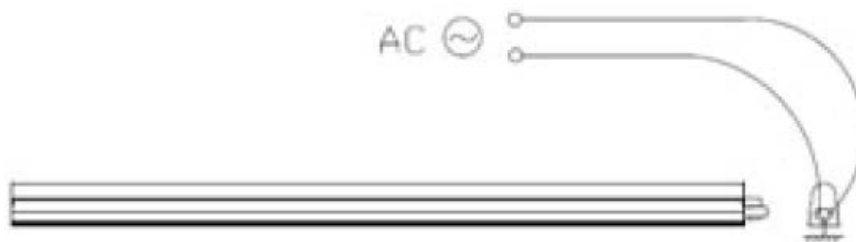

Installation Method (安裝方法)

(A)

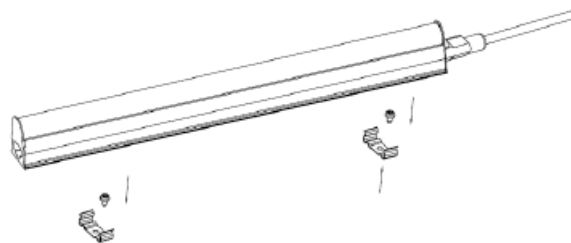

- ①: Stabilize mounting bracket on mounting area with screws (用螺絲將安裝支架固定在安裝區域)
(not required if unnecessary)
- ②: Snap tube fixture onto the mounting bracket (將管夾固定在安裝支架上)
- ③: Connect AC circuit (連接交流電路)

GT51-SDXXX9X-5W-XXX Data Sheet

(B)

Tube fixture parallel connection(燈管固定並連)

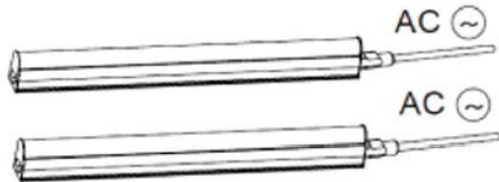

Tube fixture serial connection 1 (燈管固定串連 1)

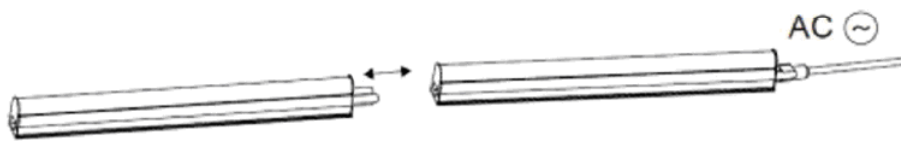

Tube fixture serial connection 2 (燈管固定串連 2)

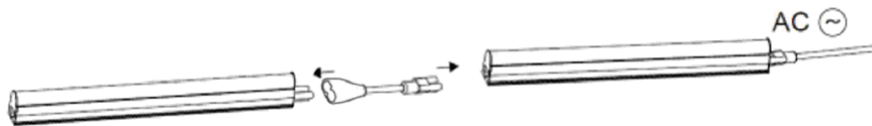

Connection Limit(連接限制): Max. tube connection length at 110V: 32ft(燈管串接長度 110V: 32 尺)

Max. tube connection length at 220V: 64ft(燈管串接長度 220V: 64 尺)

Dimensions of Carton (包裝)

Carton: 50PCS UNIT BOXES (50 支為一箱)

Packing size: 350MM(L)*270MM(W)225MM(H) (包裝尺寸)

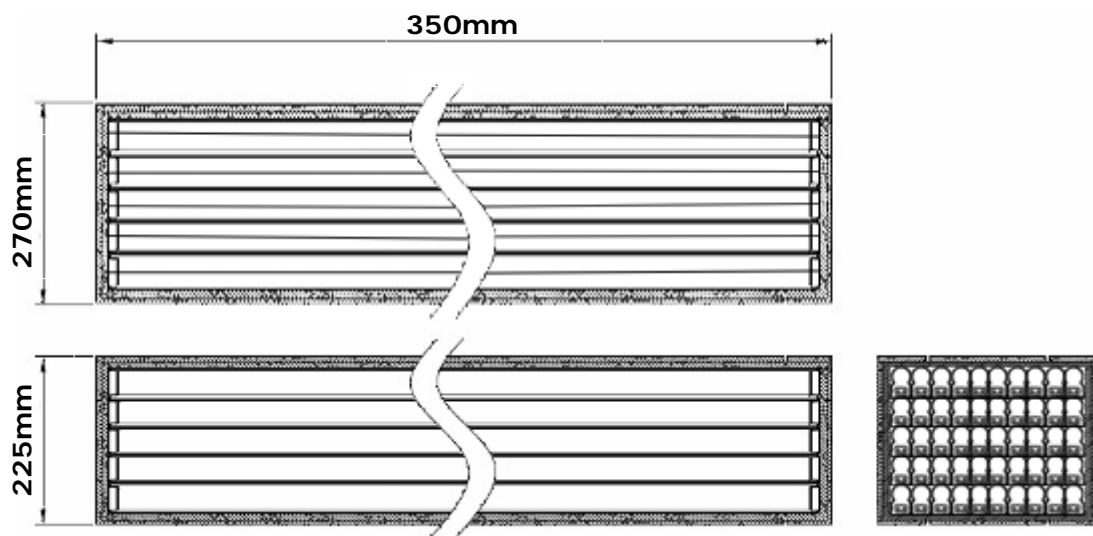

Notes: Tolerances unless dimensions $\pm 5\text{mm}$ (沒注公差的數據公差為: $\pm 5\text{mm}$)

GT52-SDXXX9X-9W-XXX Data Sheet

Features (產品特徵)

- ◆ Maintenance free, easy installation
(免維護, 安裝方便)
- ◆ No need ballast, power in-built, plug and play
(不需要安定器, 內置電源, 即插即用)
- ◆ NO UV or IR light radiation
(沒有紫外線和紅外線輻射光)
- ◆ Long Lifetime >40000 hours
(壽命>40000小時)
- ◆ Power consumption up to **9W** for lengths **572 mm**
(消耗功率:9W, 燈管長度:572MM)
- ◆ No fluorescent flickering
(沒有螢光燈的閃爍問題)
- ◆ No mercury and ROHS compliant
(沒有汞可通過無鉛環保認證)



Typical Applications (典型應用)

- ◆ Indoor Lighting (室內照明)
- ◆ Architectural Lighting (建築照明)
- ◆ Office Lighting (辦公照明)
- ◆ Decorative lighting (裝飾照明)
- ◆ T5 Luminaire Replacement (替代傳統 T5 光源)

Product Specifications (產品規格)

| Parameter(參數) | Description(描述) |
|-----------------------------|------------------------------------|
| Optical lens (透光罩) | Plastic Cover optical lens(PC 擴光罩) |
| Housing (主體) | Heat dissipation Plastic (散熱塑膠) |
| Operation Temperature(操作溫度) | -20°C ~ +40°C |
| Storage Temperature(儲存溫度) | -30°C ~ +60°C |

GT52-SDXXX9X-9W-XXX Data Sheet

Part Number Explanation (產品編碼)

| Model(產品類型) | Length(長度規格) | LED Type(LED 類型) |
|------------------------------|---------------------|---------------------|
| GT52-SDXXX9X-9W-XXX | GT52-SDXXX9X-9W-XXX | GT52-SDXXX9X-9W-XXX |
| GT5: T5 Whole Tube (T5 一體燈管) | 2: 572mm (2ft) | S: SMD LED |

| CRI(顯色指數) | CCT(色溫) | COVER(PC 罩類型) |
|---------------------|---------------------|---------------------|
| GT52-SDXXX9X-9W-XXX | GT52-SDXXX9X-9W-XXX | GT52-SDXXX9X-9W-XXX |
| D: ≥ 80 Ra | 30: 2500~3500K | B: Haze(擴光霧面罩) |
| | 40: 3500~4500K | |
| | 60: 5500~6500K | |

| Input Voltage(使用電壓) | Power Factor(功率因數) | Power Specification(電壓類型) |
|---------------------|---------------------|---------------------------------|
| GT52-SDXXX9X-9W-XXX | GT52-SDXXX9X-9W-XXX | GT52-SDXXX9X-9W-XXX |
| A: AC 175~265V | 9: ≥ 0.9 | F: No certification(無安規認證) |
| C: AC 90~305V | | C: Safety certification (有安規認證) |

| Wattage(消耗功率) | Certification (安規類型) |
|---------------------|--------------------------------|
| GT52-SDXXX9X-9W-XXX | GT52-SDXXX9X-9W-XXX |
| 9W: 9W | -: BSMI certification (台灣認證) |
| | CE: CE certification (CE 認證) |
| | PSE: PSE certification(PSE 認證) |

Specifications of Haze Cover Series (擴光霧面罩參數)

| Model No. (產品型號) | | GT52-SDXXBX9X-9W-XXX | |
|------------------------------|-------------------------------|----------------------|------|
| Parameter (參數) | | Min. | Typ. |
| Power Consumption (W) (消耗功率) | | | 9 |
| Net Weight (g) (產品重量) | | | 120 |
| D30(2500~3500K) | Luminous Flux (lm) (光通量) | | 890 |
| D40(3500~4500K) | Illuminance @ 1m (lux) (1米照度) | 145 | |
| D60(5500~6500K) | Luminous Flux (lm) (光通量) | | 990 |
| | Illuminance @ 1m (lux) (1米照度) | 162 | |

Power Consumption, Weight, Luminous flux measurement allowance is $\pm 15\%$.

All specifications involving life and performance are based upon a 25°C ambient temperature. (以上資料公差為 $\pm 15\%$ 、測試的資料是在25°C的環境溫度下進行)

GT52-SDXXX9X-9W-XXX Data Sheet

Mechanical Dimensions (產品尺寸圖)

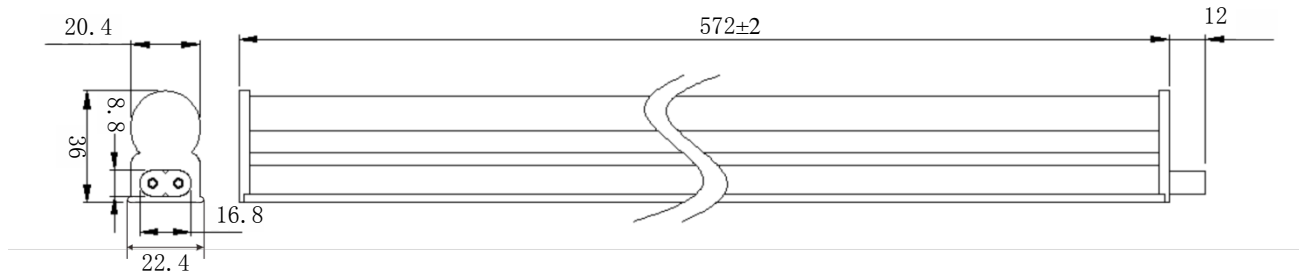

Notes(注釋): 1. Dimensions are in millimeters (上圖尺寸資料單位為: MM)

2. Tolerances unless dimensions $\pm 0.5\text{mm}$ (沒注公差的數據公差為: $\pm 0.5\text{mm}$)

Wiring Diagram (接線圖)

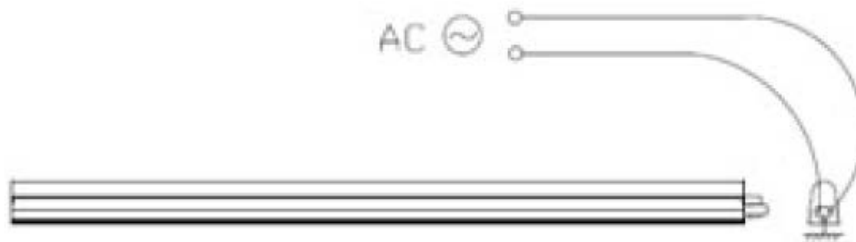

Installation Method (安裝方法)

(A)

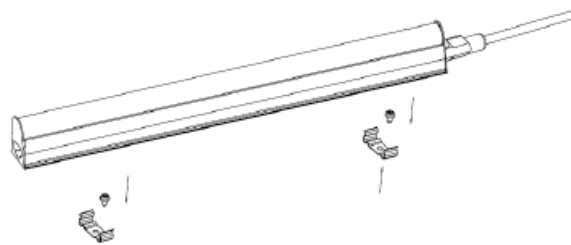

- ①: Stabilize mounting bracket on mounting area with screws (用螺絲將安裝支架固定在安裝區域)
(not required if unnecessary)
- ②: Snap tube fixture onto the mounting bracket (將管夾固定在安裝支架上)
- ③: Connect AC circuit (連接交流電路)

GT52-SDXXX9X-9W-XXX Data Sheet

(B)

Tube fixture parallel connection(燈管固定並連)

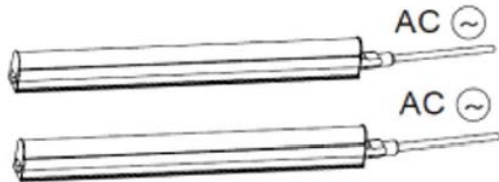

Tube fixture serial connection 1 (燈管固定串連 1)

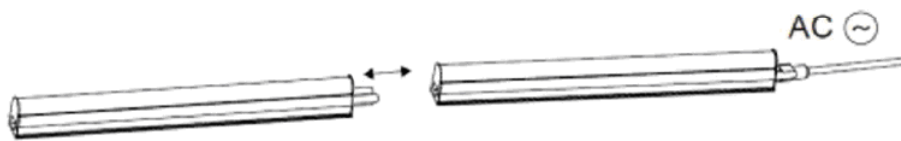

Tube fixture serial connection 2 (燈管固定串連 2)

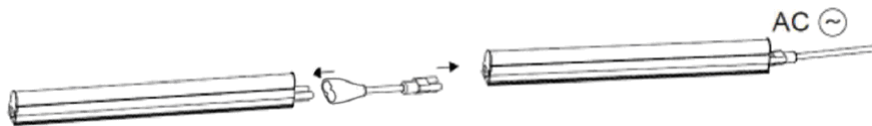

Connection Limit(連接限制): Max. tube connection length at 110V: 32ft(燈管串接長度 110V: 32 尺)

Max. tube connection length at 220V: 64ft(燈管串接長度 220V: 64 尺)

Dimensions of Carton (包裝)

Carton: 50PCS UNIT BOXES (50 支為一箱)

Packing size: 624MM(L)*270MM(W)225MM(H) (包裝尺寸)

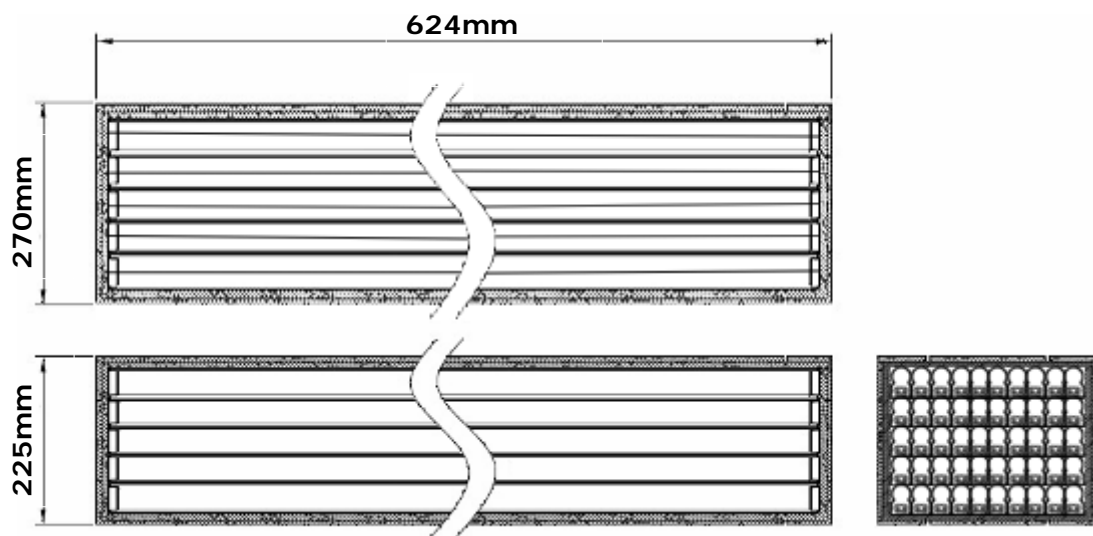

Notes: Tolerances unless dimensions $\pm 5\text{mm}$ (沒注公差的數據公差為: $\pm 5\text{mm}$)

GT53-SDXXX9X-13W-XXX Data Sheet

Features (產品特徵)

- ◆ Maintenance free, easy installation
(免維護, 安裝方便)
- ◆ No need ballast, power in-built, plug and play
(不需要安定器, 內置電源, 即插即用)
- ◆ NO UV or IR light radiation
(沒有紫外線和紅外線輻射光)
- ◆ Long Lifetime >40000 hours
(壽命>40000小時)
- ◆ Power consumption up to **13W** for
lengths **873 mm**
(消耗功率:13W, 燈管長度:873MM)
- ◆ No fluorescent flickering
(沒有螢光燈的閃爍問題)
- ◆ No mercury and ROHS compliant
(沒有汞可通過無鉛環保認證)



Typical Applications (典型應用)

- ◆ Indoor Lighting (室內照明)
- ◆ Architectural Lighting (建築照明)
- ◆ Office Lighting (辦公照明)
- ◆ Decorative lighting (裝飾照明)
- ◆ T5 Luminaire Replacement (替代傳統 T5 光源)

Product Specifications (產品規格)

| Parameter(參數) | Description(描述) |
|-----------------------------|------------------------------------|
| Optical lens (透光罩) | Plastic Cover optical lens(PC 擴光罩) |
| Housing (主體) | Heat dissipation Plastic (散熱塑膠) |
| Operation Temperature(操作溫度) | -20°C ~ +40°C |
| Storage Temperature(儲存溫度) | -30°C ~ +60°C |

GT53-SDXXX9X-13W-XXX Data Sheet

Part Number Explanation (產品編碼)

| Model(產品類型) | Length(長度規格) | LED Type(LED 類型) |
|------------------------------|-------------------------------|-------------------------------|
| GT53 -SDXXX9X-13W-XXX | GT5 3 -SDXXX9X-13W-XXX | GT53- S DXXX9X-13W-XXX |
| GT5: T5 Whole Tube (T5 一體燈管) | 3: 873mm (3ft) | S: SMD LED |

| CRI(顯色指數) | CCT(色溫) | COVER(PC 罩類型) |
|-------------------------------|--------------------------------|--------------------------------|
| GT53- S DXXX9X-13W-XXX | GT53-SD XX XX9X-13W-XXX | GT53-SDXX X X9X-13W-XXX |
| D: ≥ 80 Ra | 30: 2500~3500K | B: Haze(擴光霧面罩) |
| | 40: 3500~4500K | |
| | 60: 5500~6500K | |

| Input Voltage(使用電壓) | Power Factor(功率因數) | Power Specification(電壓類型) |
|--------------------------------|-------------------------------|---------------------------------|
| GT53-SDXXX X 9X-13W-XXX | GT53-SDXXX 9 X-13W-XXX | GT53-SDXXX 9X -13W-XXX |
| A: AC 175~265V | 9: ≥ 0.9 | F: No certification(無安規認證) |
| C: AC 90~305V | | C: Safety certification (有安規認證) |

| Wattage(消耗功率) | Certification (安規類型) |
|-------------------------------|--------------------------------|
| GT53-SDXXX9X- 13W -XXX | GT53-SDXXX9X-13W- XXX |
| 13W: 13W | -: BSMI certification (台灣認證) |
| | CE: CE certification (CE 認證) |
| | PSE: PSE certification(PSE 認證) |

Specifications of Haze Cover Series (擴光霧面罩參數)

| Model No. (產品型號) | | GT53-SDXXB9X-13W-XXX | |
|------------------------------|-------------------------------|----------------------|------|
| Parameter (參數) | | Min. | Typ. |
| Power Consumption (W) (消耗功率) | | | 13 |
| Net Weight (g) (產品重量) | | | 150 |
| D30(2500~3500K) | Luminous Flux (lm) (光通量) | | 1285 |
| D40(3500~4500K) | Illuminance @ 1m (lux) (1米照度) | 194 | |
| D60(5500~6500K) | Luminous Flux (lm) (光通量) | | 1430 |
| | Illuminance @ 1m (lux) (1米照度) | 216 | |

Power Consumption, Weight, Luminous flux measurement allowance is $\pm 15\%$.

All specifications involving life and performance are based upon a 25°C ambient temperature. (以上資料公差為 $\pm 15\%$ 、測試的資料是在25°C的環境溫度下進行)

GT53-SDXXX9X-13W-XXX Data Sheet

Mechanical Dimensions (產品尺寸圖)

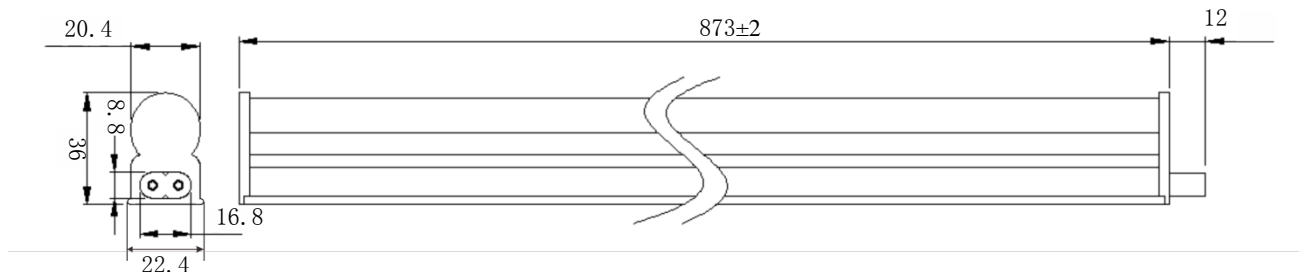

Notes(注釋): 1. Dimensions are in millimeters (上圖尺寸資料單位為: MM)

2. Tolerances unless dimensions $\pm 0.5\text{mm}$ (沒注公差的數據公差為: $\pm 0.5\text{mm}$)

Wiring Diagram (接線圖)

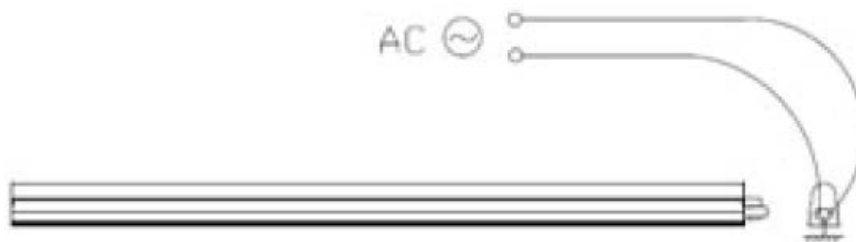

Installation Method (安裝方法)

(A)

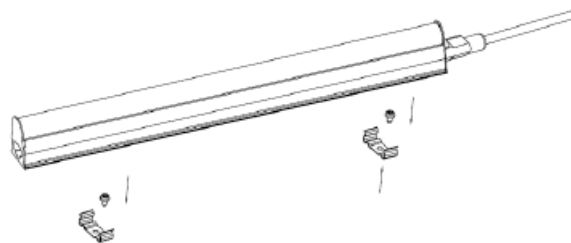

- ①: Stabilize mounting bracket on mounting area with screws (用螺絲將安裝支架固定在安裝區域)
(not required if unnecessary)
- ②: Snap tube fixture onto the mounting bracket (將管夾固定在安裝支架上)
- ③: Connect AC circuit (連接交流電路)

GT53-SDXXX9X-13W-XXX Data Sheet

(B)

Tube fixture parallel connection(燈管固定並連)



Tube fixture serial connection 1 (燈管固定串連 1)

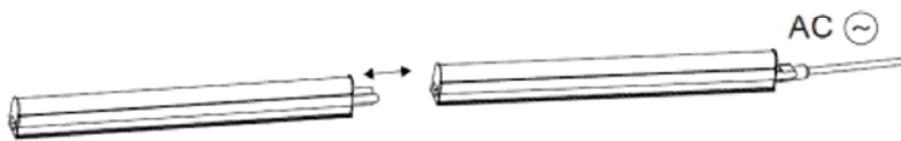

Tube fixture serial connection 2 (燈管固定串連 2)

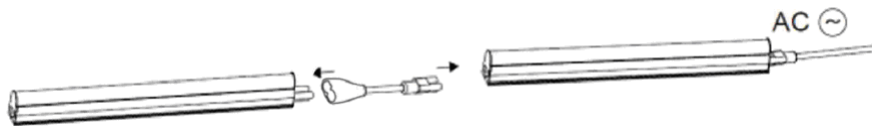

Connection Limit(連接限制): Max. tube connection length at 110V: 32ft(燈管串接長度 110V: 32 尺)

Max. tube connection length at 220V: 64ft(燈管串接長度 220V: 64 尺)

Dimensions of Carton (包裝)

Carton: 50PCS UNIT BOXES (50 支為一箱)

Packing size: 925MM(L)*270MM(W)225MM(H) (包裝尺寸)

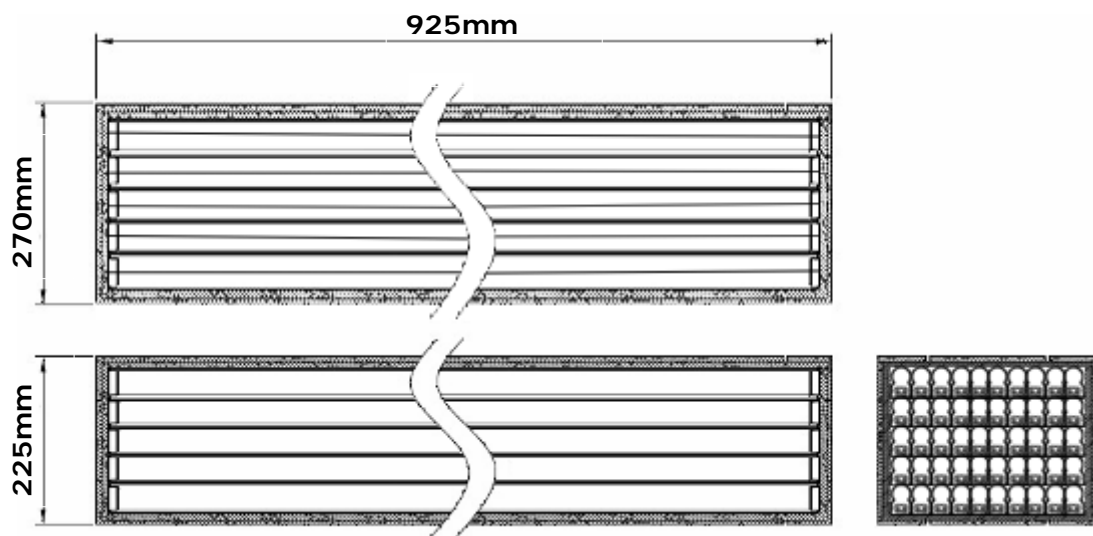

Notes: Tolerances unless dimensions $\pm 5\text{mm}$ (沒注公差的數據公差為: $\pm 5\text{mm}$)

GT54-SDXXX9X-18W-XXX Data Sheet

Features (產品特徵)

- ◆ Maintenance free, easy installation
(免維護, 安裝方便)
- ◆ No need ballast, power in-built, plug and play
(不需要安定器, 內置電源, 即插即用)
- ◆ NO UV or IR light radiation
(沒有紫外線和紅外線輻射光)
- ◆ Long Lifetime >40000 hours
(壽命>40000小時)
- ◆ Power consumption up to **18W** for
lengths **1177 mm**
(消耗功率:18W, 燈管長度:1177MM)
- ◆ No fluorescent flickering
(沒有螢光燈的閃爍問題)
- ◆ No mercury and ROHS compliant
(沒有汞可通過無鉛環保認證)



Typical Applications (典型應用)

- ◆ Indoor Lighting (室內照明)
- ◆ Architectural Lighting (建築照明)
- ◆ Office Lighting (辦公照明)
- ◆ Decorative lighting (裝飾照明)
- ◆ T5 Luminaire Replacement (替代傳統 T5 光源)

Product Specifications (產品規格)

| Parameter(參數) | Description(描述) |
|-----------------------------|------------------------------------|
| Optical lens (透光罩) | Plastic Cover optical lens(PC 擴光罩) |
| Housing (主體) | Heat dissipation Plastic (散熱塑膠) |
| Operation Temperature(操作溫度) | -20°C ~ +40°C |
| Storage Temperature(儲存溫度) | -30°C ~ +60°C |

GT54-SDXXX9X-18W-XXX Data Sheet

Part Number Explanation (產品編碼)

| Model(產品類型) | Length(長度規格) | LED Type(LED 類型) |
|------------------------------|-------------------------------|-------------------------------|
| GT54 -SDXXX9X-18W-XXX | GT5 4 -SDXXX9X-18W-XXX | GT54- S DXXX9X-18W-XXX |
| GT5: T5 Whole Tube (T5 一體燈管) | 4: 1177mm (4ft) | S: SMD LED |

| CRI(顯色指數) | CCT(色溫) | COVER(PC 罩類型) |
|-------------------------------|--------------------------------|--------------------------------|
| GT54- S DXXX9X-18W-XXX | GT54-SD XX XX9X-18W-XXX | GT54-SDXX X X9X-18W-XXX |
| D: ≥ 80 Ra | 30: 2500~3500K | B: Haze(擴光霧面罩) |
| | 40: 3500~4500K | |
| | 60: 5500~6500K | |

| Input Voltage(使用電壓) | Power Factor(功率因數) | Power Specification(電壓類型) |
|--------------------------------|-------------------------------|---------------------------------|
| GT54-SDXXX X 9X-18W-XXX | GT54-SDXXX 9 X-18W-XXX | GT54-SDXXX 9X -18W-XXX |
| A: AC 175~265V | 9: ≥ 0.9 | F: No certification(無安規認證) |
| C: AC 90~305V | | C: Safety certification (有安規認證) |

| Wattage(消耗功率) | Certification (安規類型) |
|-------------------------------|--------------------------------|
| GT54-SDXXX9X- 18W -XXX | GT54-SDXXX9X-18W- XXX |
| 18W: 18W | -: BSMI certification (台灣認證) |
| | CE: CE certification (CE 認證) |
| | PSE: PSE certification(PSE 認證) |

Specifications of Haze Cover Series (擴光霧面罩參數)

| Model No. (產品型號) | | GT54-SDXXB9X-18W-XXX | |
|------------------------------|-------------------------------|----------------------|------|
| Parameter (參數) | | Min. | Typ. |
| Power Consumption (W) (消耗功率) | | | 18 |
| Net Weight (g) (產品重量) | | | 180 |
| D30(2500~3500K) | Luminous Flux (lm) (光通量) | | 1780 |
| D40(3500~4500K) | Illuminance @ 1m (lux) (1米照度) | 270 | |
| D60(5500~6500K) | Luminous Flux (lm) (光通量) | | 1980 |
| | Illuminance @ 1m (lux) (1米照度) | 300 | |

Power Consumption, Weight, Luminous flux measurement allowance is $\pm 15\%$.

All specifications involving life and performance are based upon a 25°C ambient temperature. (以上資料公差為 $\pm 15\%$ 、測試的資料是在25°C的環境溫度下進行)

GT54-SDXXX9X-18W-XXX Data Sheet

Mechanical Dimensions (產品尺寸圖)

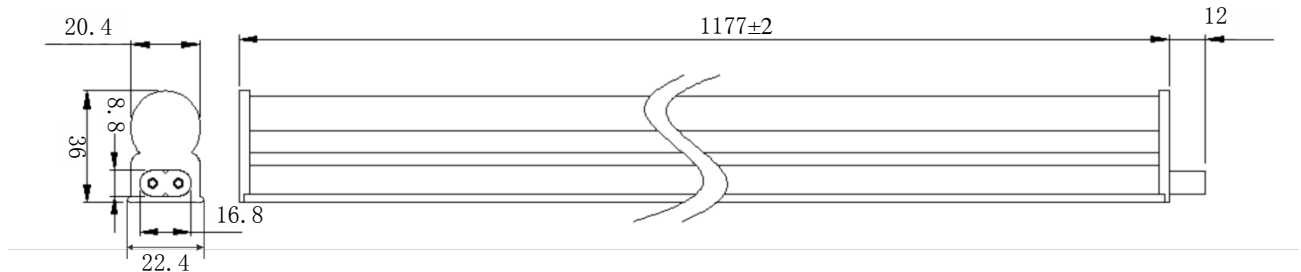

Notes(注釋): 1. Dimensions are in millimeters (上圖尺寸資料單位為: MM)

2. Tolerances unless dimensions $\pm 0.5\text{mm}$ (沒注公差的數據公差為: $\pm 0.5\text{mm}$)

Wiring Diagram (接線圖)

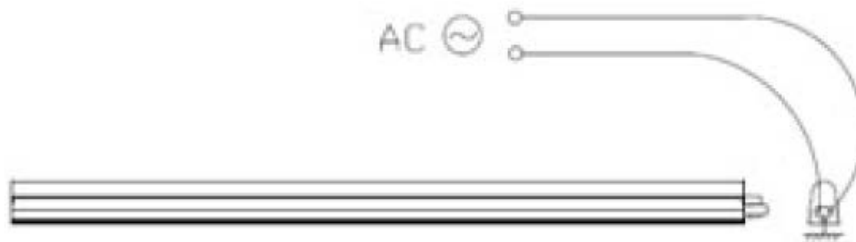

Installation Method (安裝方法)

(A)

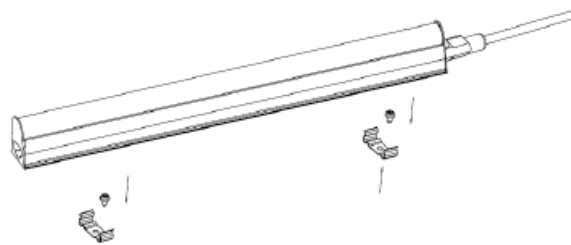

- ①: Stabilize mounting bracket on mounting area with screws (用螺絲將安裝支架固定在安裝區域)
(not required if unnecessary)
- ②: Snap tube fixture onto the mounting bracket (將管夾固定在安裝支架上)
- ③: Connect AC circuit (連接交流電路)

GT54-SDXXX9X-18W-XXX Data Sheet

(B)

Tube fixture parallel connection(燈管固定並連)

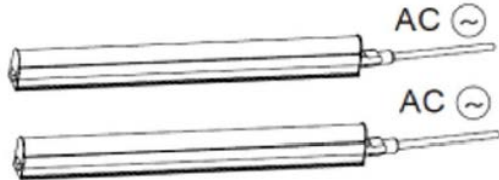

Tube fixture serial connection 1 (燈管固定串連 1)

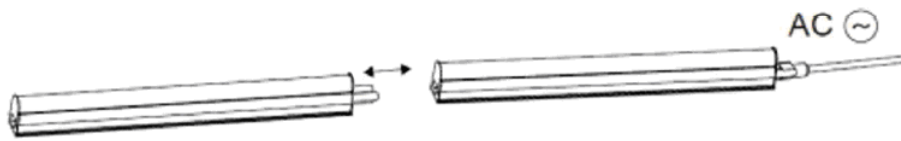

Tube fixture serial connection 2 (燈管固定串連 2)

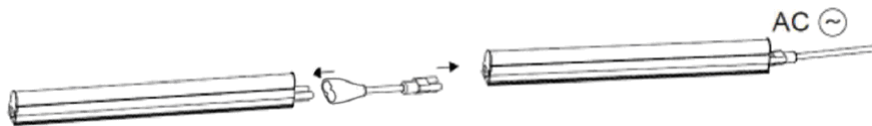

Connection Limit(連接限制): Max. tube connection length at 110V: 32ft(燈管串接長度 110V: 32 尺)

Max. tube connection length at 220V: 64ft(燈管串接長度 220V: 64 尺)

Dimensions of Carton (包裝)

Carton: 50PCS UNIT BOXES (50 支為一箱)

Packing size: 1229MM(L)*270MM(W)225MM(H) (包裝尺寸)

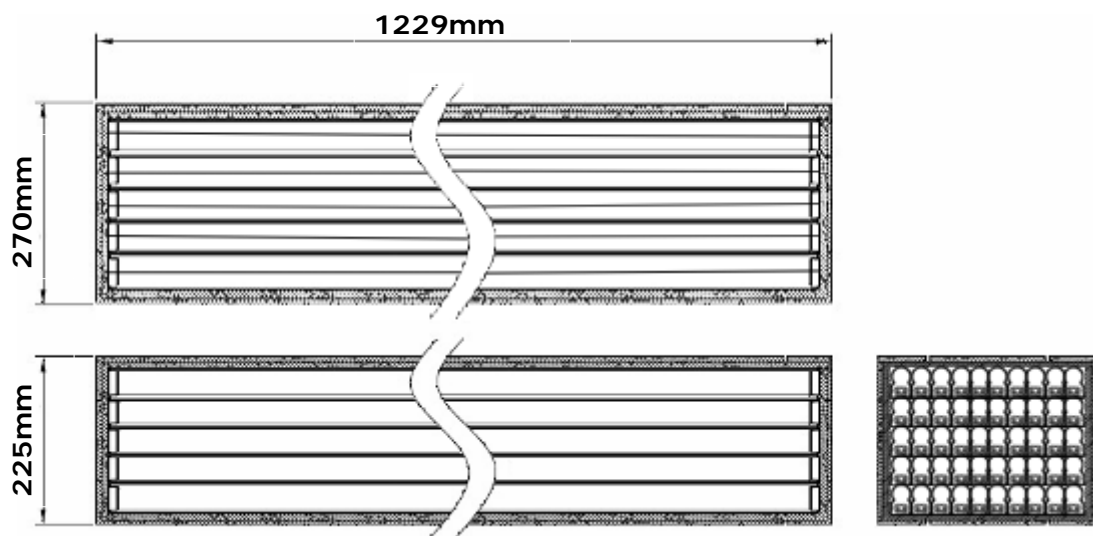

Notes: Tolerances unless dimensions $\pm 5\text{mm}$ (沒注公差的數據公差為: $\pm 5\text{mm}$)